

# Times Protect<sup>®</sup>

## **Grounding & Lightning Protection for Wireless Networks**

- **Overview of the Lightning Event**
- **Protection Techniques for Radio Equipment**
- **Why are Coaxial Cable Lightning Protectors Required**
- **Site Grounding Principles**

## Overview of Lightning Event

This paper will examine the characteristics of a cloud to earth strike, and the resulting probability of damage to existing wireless infrastructure. Most wireless networks rely on tall communication towers causing a statistically high lightning exposure probability. Typically, more than 2,000 thunderstorms are active throughout the world at any given moment producing on the order of 100 flashes per second. As our society becomes more dependent upon computers and communications networks, protection from system disruptions becomes essential.

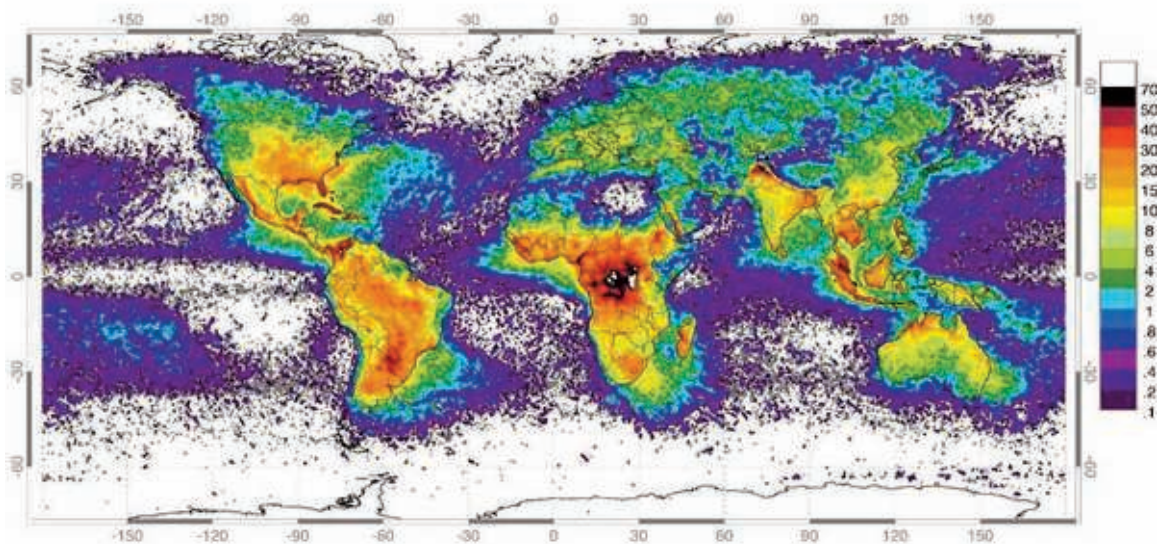

**High Resolution Full Climatology Annual Flash Rate**

Global distribution of lightning April 1995-February 2003 from the combined observations of the NASA OTD (4/95-3/00) and LIS (1/98-2/03) instruments

The conditions necessary for a thunderstorm are warm moist air from ground level to a few thousand feet, cooler air above with little to no wind, and full sun to heat the air mass near the ground. As the heated air near the ground rises to heights where the temperature is below freezing, a thundercloud is formed. Within the thundercloud, constant collisions among ice particles driven by rising and falling air columns causes static charge build up. Eventually the static charge becomes sufficiently large to cause the air to breakdown. An initial small charge called a “step leader” breaks out seeking an ideal cloud to cloud or cloud to earth path. Once this path is found the main series of strokes follow.

Lightning is a natural event with many unknown geographic, climatological, and electrical influences determining strike characteristics. Rf communication engineers, systems suppliers, and users, are accumulating data to understand what site configurations, lightning protectors, and grounding systems might be necessary to bypass sensitive electronics equipment and safely conduct lightning energy to earth. The following information is intended to help implement that goal.

### *Lightning as a Statistical Event*

- Local thunderstorms determine the strike probability for any given tower
- A thunderstorm day is defined as a local calendar day where thunder is heard
- Prediction of a lightning strike to a specific object is not an exact science; however, thunderstorm day data is the only related parameter collected since the early 1900's
- Isokeraunic charts are developed from thunderstorm day statistics

***The following information is extracted from recognized government and industrial standards, as indicated with references***

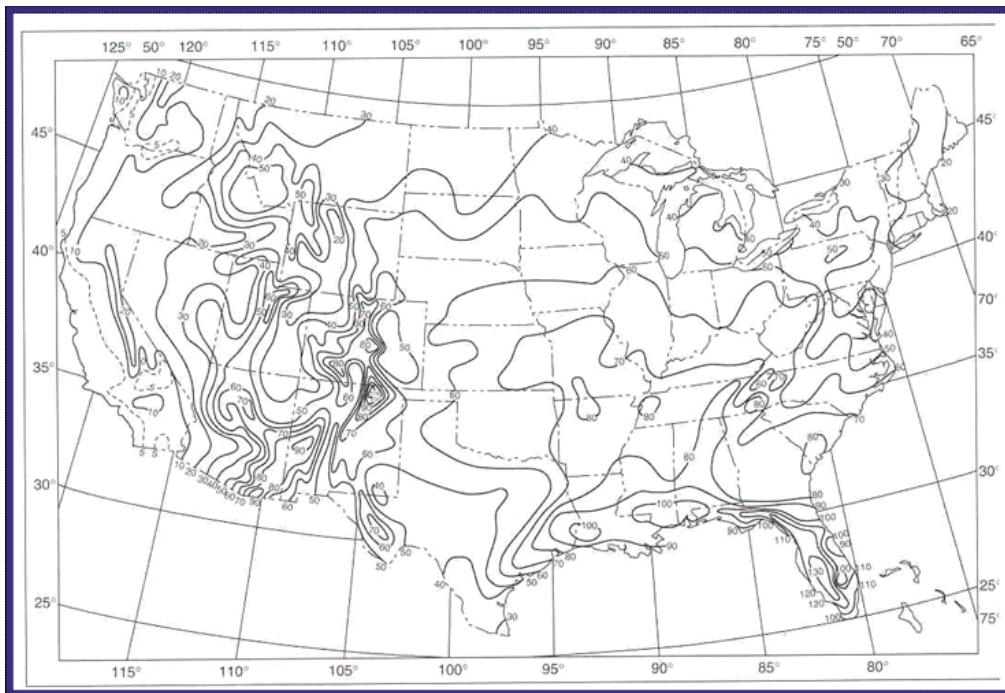

***Ref: Mean Annual Number of Days with Thunderstorms (1948-1972),  
U.S. Department of Commerce, Environmental Science Administration***

Electrical breakdowns caused by over-voltages due to lightning are responsible for considerable property damage and business interruption. No section of the United States is immune, although in the Pacific Coast area lightning storms are infrequent. The Southeastern and South Central States experience the largest number of lightning storms each year.

The amount of lightning activity in any area can be determined by the Stroke Density, strokes / sq. km/unit time map.

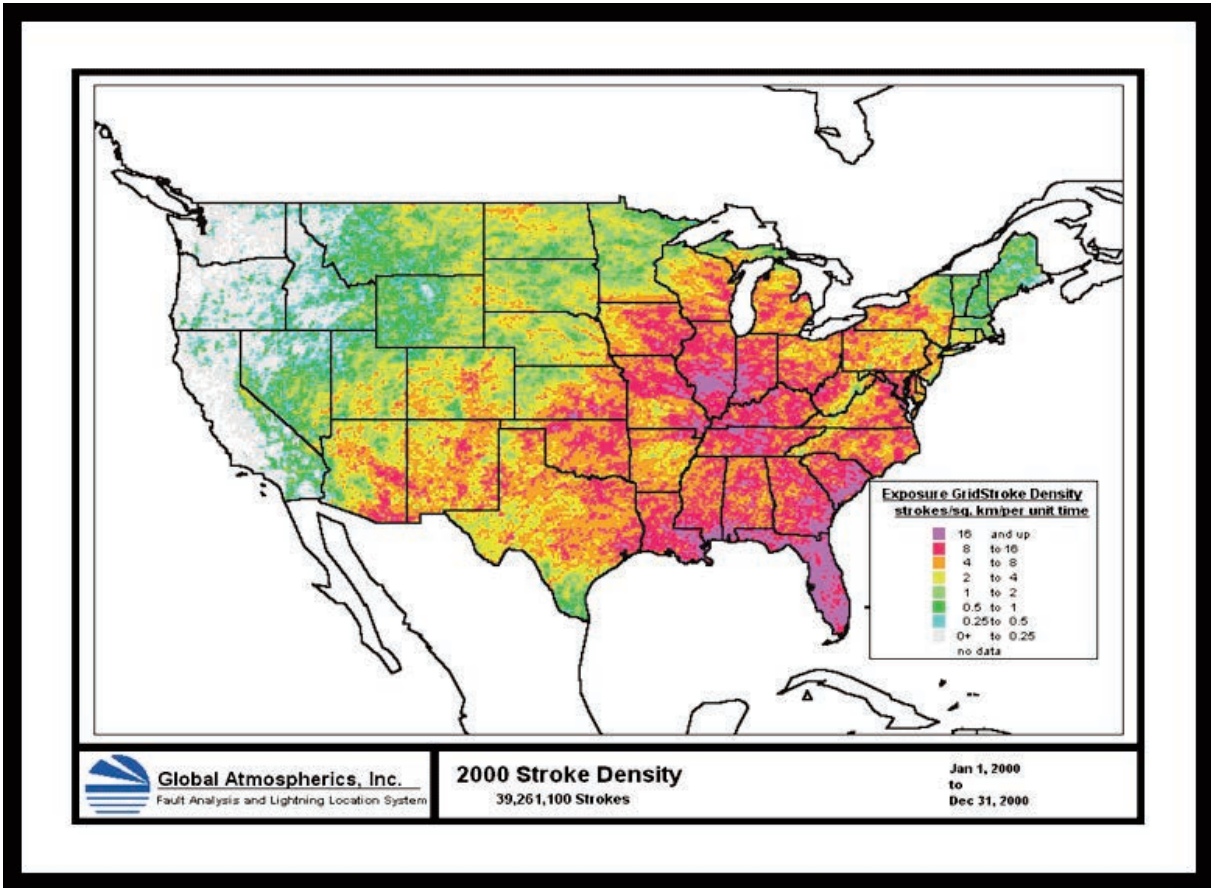

### Definitions of Lightning Voltage and Current Parameters

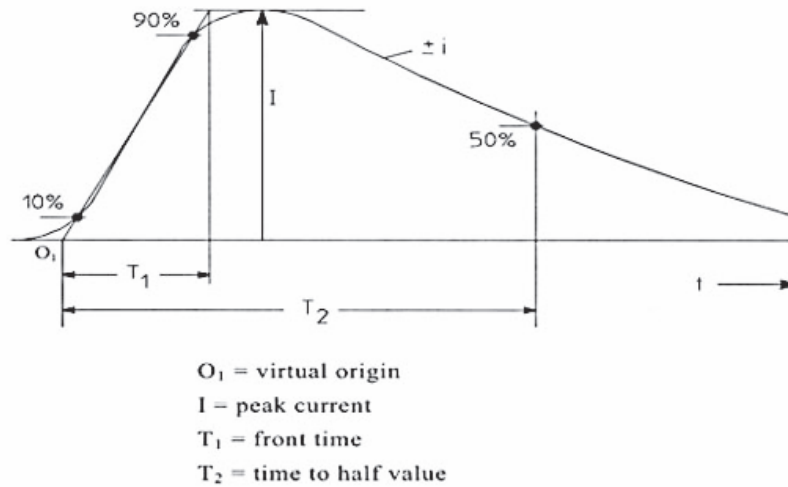

Figure A.1 - Definitions of short stroke parameters ( Typically  $T_2 < 2$  ms )

Lightning voltage can only be estimated since the cloud will produce whatever voltage is necessary to breakdown the atmosphere under varying weather and terrain. Peak voltages can be calculated from current flow, but only across the resistance (inductance) of a known conductor in the lightning path.

Since Lightning is a pulse waveform, researchers also measure lightning in terms of rise time to peak stroke current. Some researchers recorded the rise time from zero to peak and others recorded from 10% to 90%. When we analyze the chart, we can determine that the maximum current rise-time is about 10 microseconds and the minimum is 0.7 microseconds.

Although lightning is a dc current event, the fast change from no current to peak current will cause an inductive voltage drop across any conductor. Direct and magnetic field coupled damage can be severe. A multiple strike event pumps energy into a ground system that, unless properly designed with a fast transient response, will quickly saturate causing a rapid rise in GPR even though it might measure 5 Ohms with a ground tester.

If we convert from a time domain measurement in  $\mu\text{s}$  (see rise time graphs) to a frequency measurement in Hz, we find considerable energy from 100Hz, peaking at 50-100 kHz and rolling off up to 1MHz caused by the fast rise time dc current pulse. There is still detectable energy up and through the wireless range of frequencies that can damage sensitive receiver rf input circuits.

## Measured Peak Lightning Currents

**350kA**  
Maximum with  
99.5%  
Confidence  
Level

**300kA**  
Maximum with  
98%  
Confidence  
Level

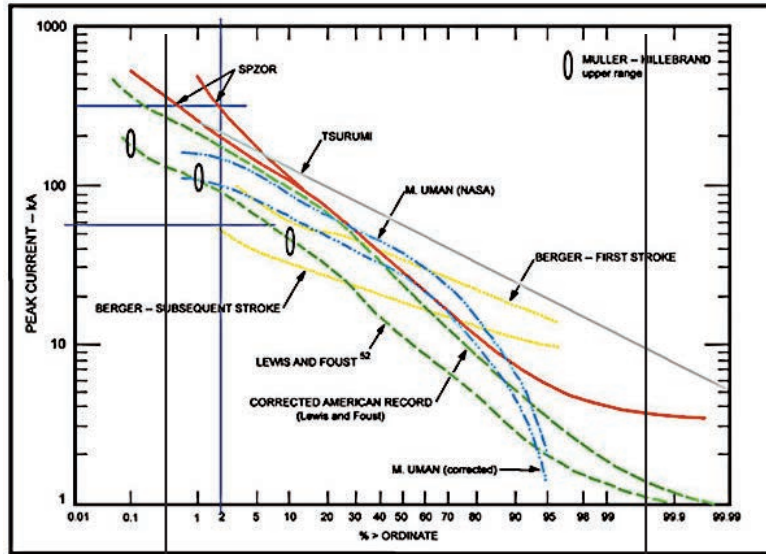

Figure 3.5 - Measured Peak Currents<sup>2</sup>

Six  $\sigma$  Distribution

Ref: W.C. Hart, E.W. Malone, *Lightning and Lightning protection*, EEE Press, 1979

## Time to Peak Lightning Currents

Max. 10 $\mu$ -sec  
Min. 0.7 $\mu$ -sec  
0 to peak current with 55%  
confidence level

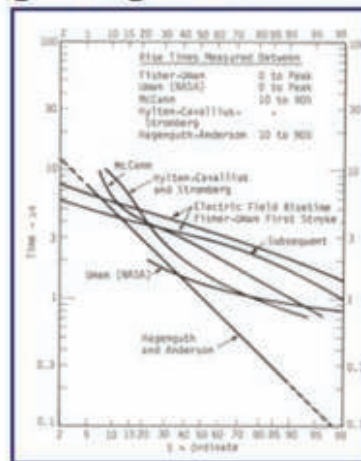
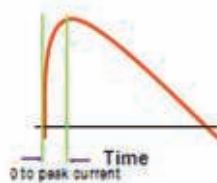

Ref: W.C. Hart, E.W. Malone, *Lightning and Lightning Protection*, EEE Press, 1979

### Multiple Return Strokes

A Lightning event can have as many as 30 (very rare) additional lower current return strokes based on the impedance of the conductive channel and the charged cloud's ability to migrate electrons to the discharge area. A typical Lightning event might have 2 or 3 lower energy return strokes. Total energy through the struck object will be elevated to higher levels as the number of return strokes increases.

### Continuing Current Strokes

Any one (or more) of multiple return strokes can have the pulse decay extended from 35 to 550 milliseconds. During the extended time line, continuing lightning currents can cause damage to equipment that might have survived the initial series of short duration, high current pulses. The short duration, fast rise time current on the coaxial cables from the tower to entry panel will create a substantial inductive voltage drop that, along with the dc resistance of the cable, will reduce current flow to equipment. But the long duration dc "surge" following a fast rise time event will be reduced only by the dc resistance of the cables. There can be from 30 to 1000 Amps delivered to the coaxial cable entry panel for 35 to 550 Milliseconds. Proper entry panel grounding is essential.

### Duration & Amplitude of Continuing Currents

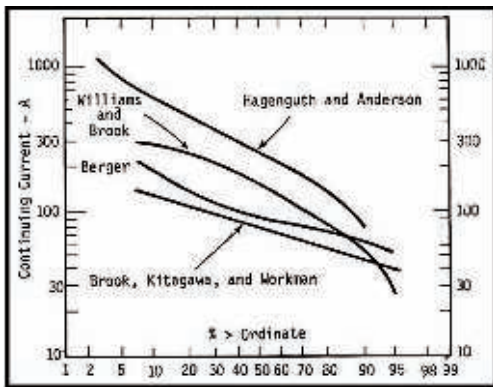

**Max. 1000A**  
**Min. 30A**  
0 to peak current with 96% confidence level

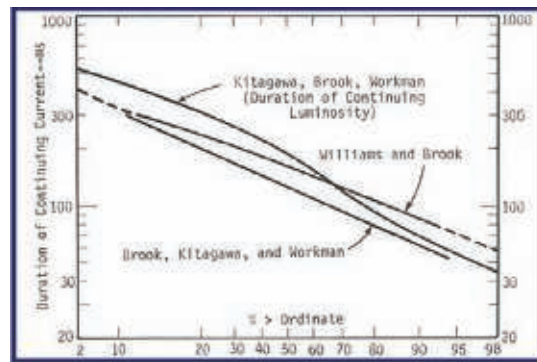

**Max. 550m-sec**  
**Min. 35m-sec**  
0 to peak current with 96% confidence level

Ref: N. Clanos and E.T. Pierce, "A Ground Lightning Environment for Engineering Usage", Contract L.S.-28170A-3, Stanford Research Institute, CA

Continuing currents could be caused by the discharging of unused previously extended step leaders in to the lightning channel, and the collapse of the channel's surrounding magnetic field once the cloud charge potential cannot overcome the channel's impedance to earth.

### *Protection Techniques for Equipment Connected to the Antenna Feeder Cable*

The coaxial antenna feeder cable is the primary source of damaging lightning energy to equipment at a communications site. When struck by lightning, the tower acts like a voltage divider. For a few nanoseconds, there will be a high peak voltage at the top referenced to zero voltage at the base. Current will then flow through the tower and all attached conductors. The rise time and amount of current directed toward the equipment will be determined by:

- Strike characteristics
- How high above earth the coaxial cable shields are grounded to the tower before they turn towards the building / cabinet entry.
- The inductance of the tower with coaxial cables, and below without coaxial cables
- The series inductance of the coaxial cables turning to enter the building/cabinet
- The parallel inductance of the building /cabinet entry conductors to ground

If the bottom coaxial cable ground kit (where the coaxial cable leaves the tower) is at any elevation above the earth, the overall inductance to earth of the tower below the ground kit, the series inductance of coaxial cables to the building, and the paralleled entry panel ground conductors, is sufficient to cause a substantial peak voltage. The resulting voltage on the coax shield will drive current to the equipment where the electrical safety ground provides a path to ground through the equipment chassis.

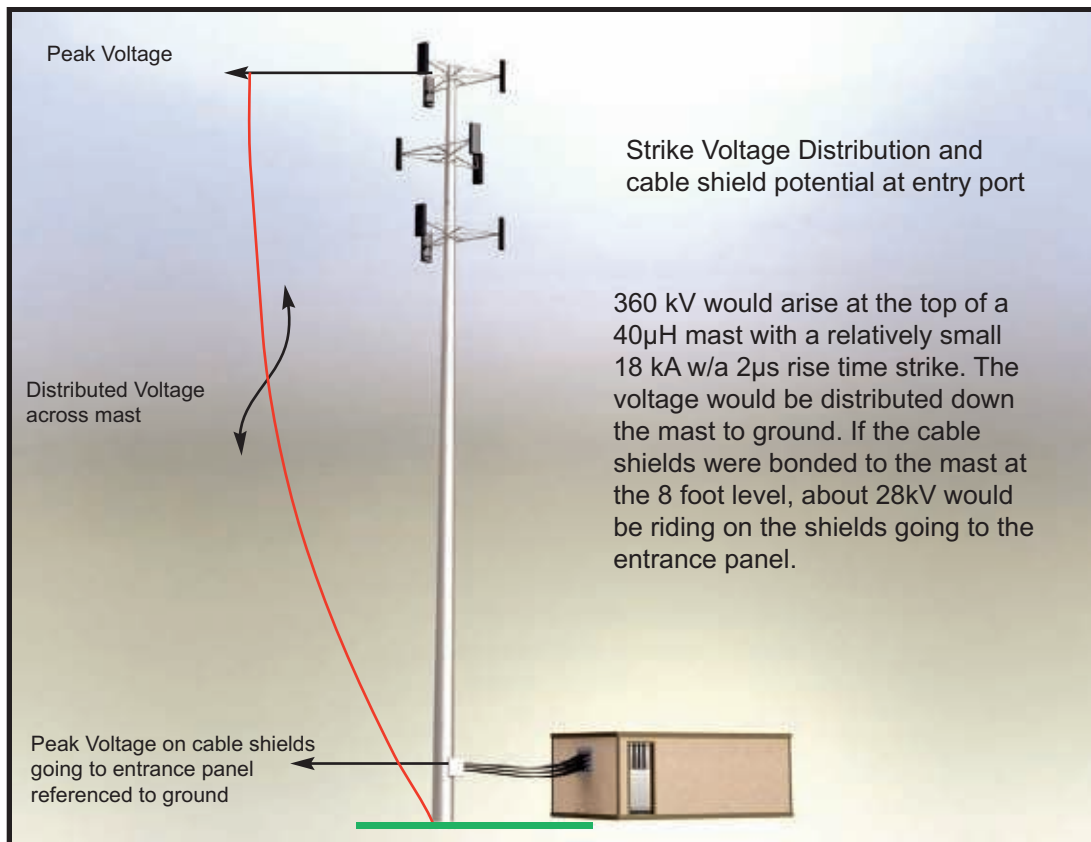



## *An Additional Ground Kit Can Reduce Coaxial Cable Damage*

### Coaxial Cable Ground Kit Placement

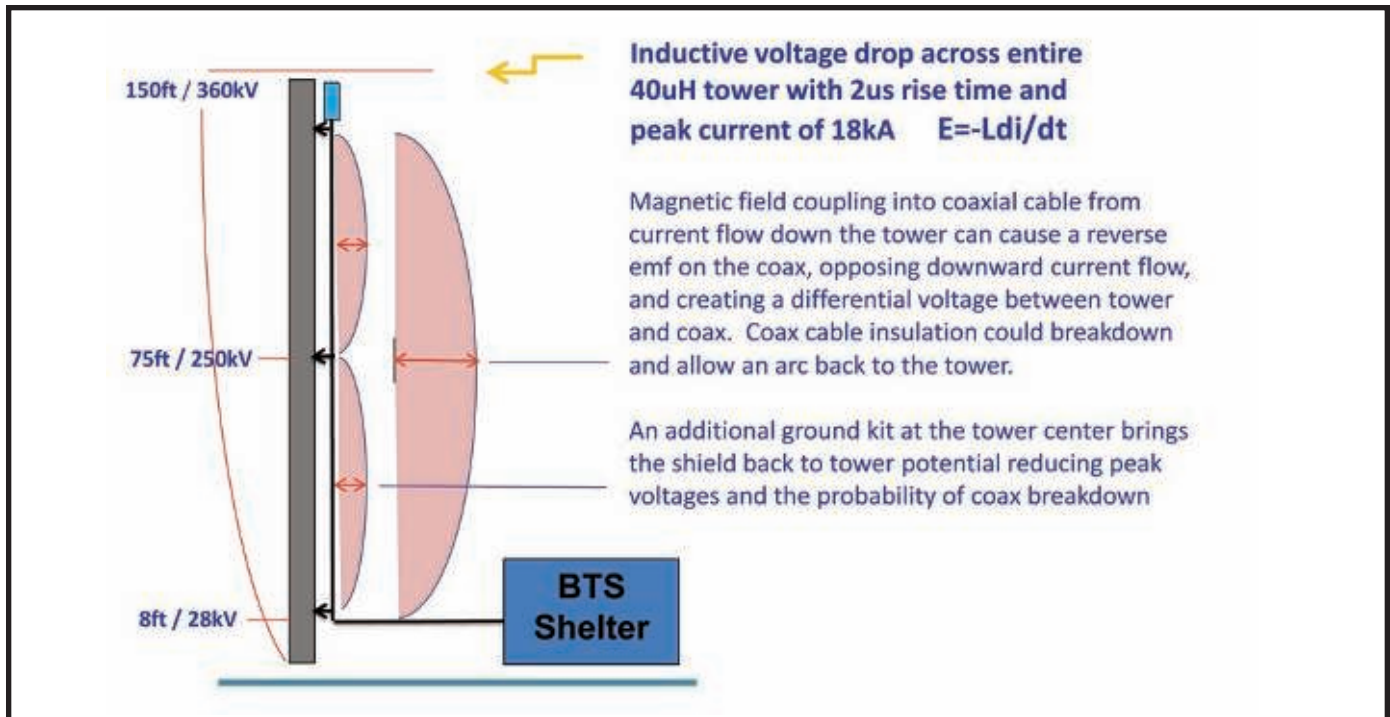

The number of ground kits applied varies with tower height and size/number of coax cable runs.

Approximate number of ground kits suggested for each cable run:

- Towers less than 100 feet, one ground kit at top and bottom of coax run
- Towers from 100 – 200 feet, one ground kit at top, middle, and bottom of coax run
- Towers from 200 – feet and up, one ground kit every 75 – 100 feet of coax run
- A larger tower cross-section reduces the overall series inductance resulting in less voltage drop across the tower, allowing wider ground kit spacing
- Multiple coaxial cable runs would further reduce the overall series inductance

The best way to prevent lightning caused coaxial shield currents from reaching equipment is to minimize the peak voltage at the building entry panel. This may be accomplished by installing, on the inside of the building, a continuous conductive ground plane bonded to the building ground system. The large surface area ground plane is necessary to provide a low inductance path to ground for the entry panel's peak surge current as well as provide for the high frequency component of the strike. Each coaxial line as it enters the building is attached to the panel with a grounded protector/feed through or an additional grounding kit.

A recommended entry system would provide a continuous surface area "single point ground" plane from the coaxial cable entry to the building ground system. A continuous surface area ground plane:

- Keeps inductance low with no mutual coupling (as with parallel ground straps)
- Minimizes inductive voltage drop during lightning event
- Improves MGB (Master Ground Bar) performance
- Provides a low impedance single point ground return path for lightning transients

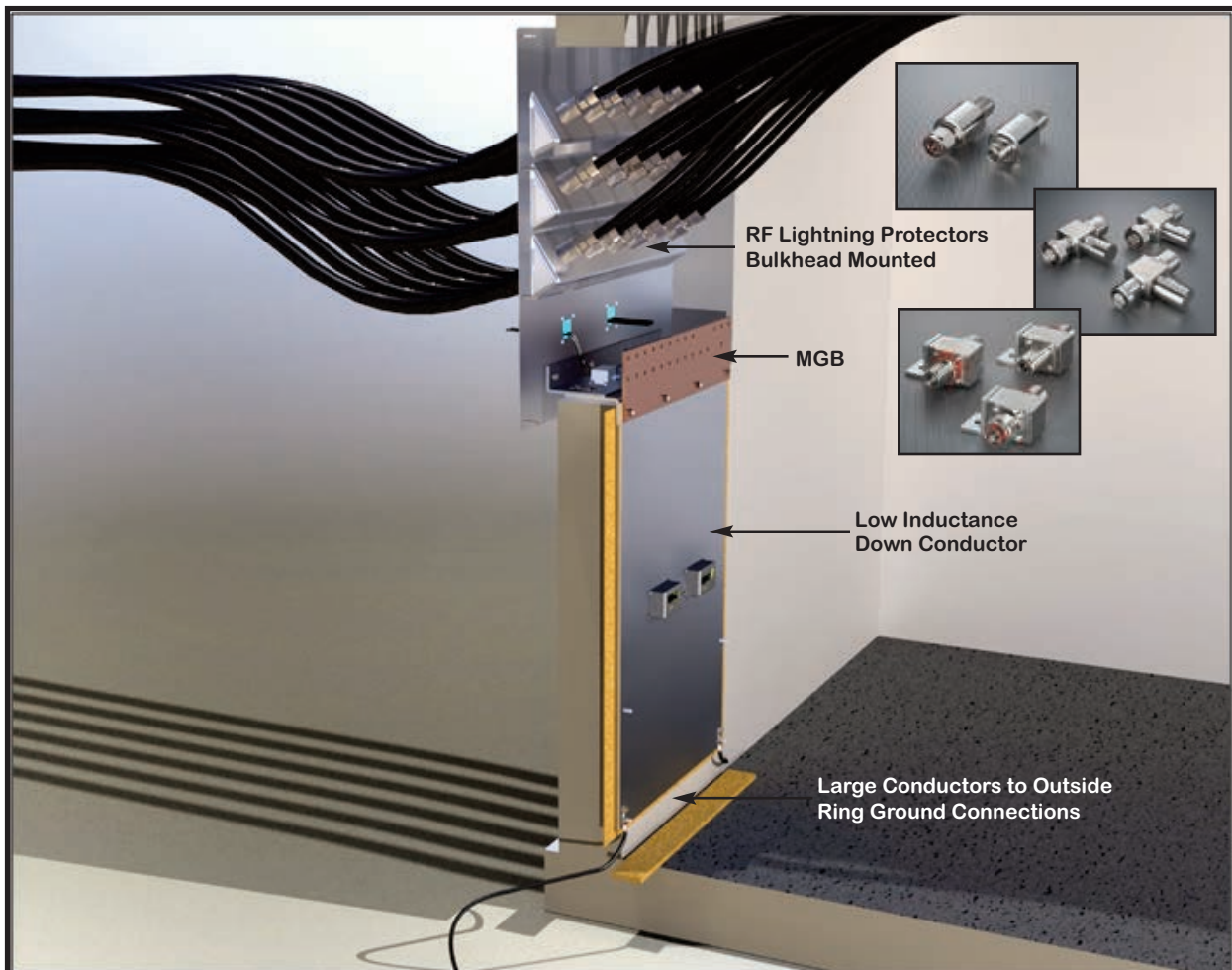

In a 100kA strike computer simulation, the amount of strike current delivered to the entry plate is determined by:

- The tower's inductance to earth below where the coaxial cables are bonded to the tower and turned toward the entry panel,
- The inductance of the paralleled coaxial cables directed to the entry panel
- The inductance / impedance of the entry port / master ground bar to ground at lightning transient frequencies .

The amount of current on each of the (same sized) coaxial cables would be determined by the peak current on all coaxial cables at the elevated coaxial cable shield / tower ground connection, divided by the number of coaxial cables routed to the entry panel.

### Lightning Strike Current Division

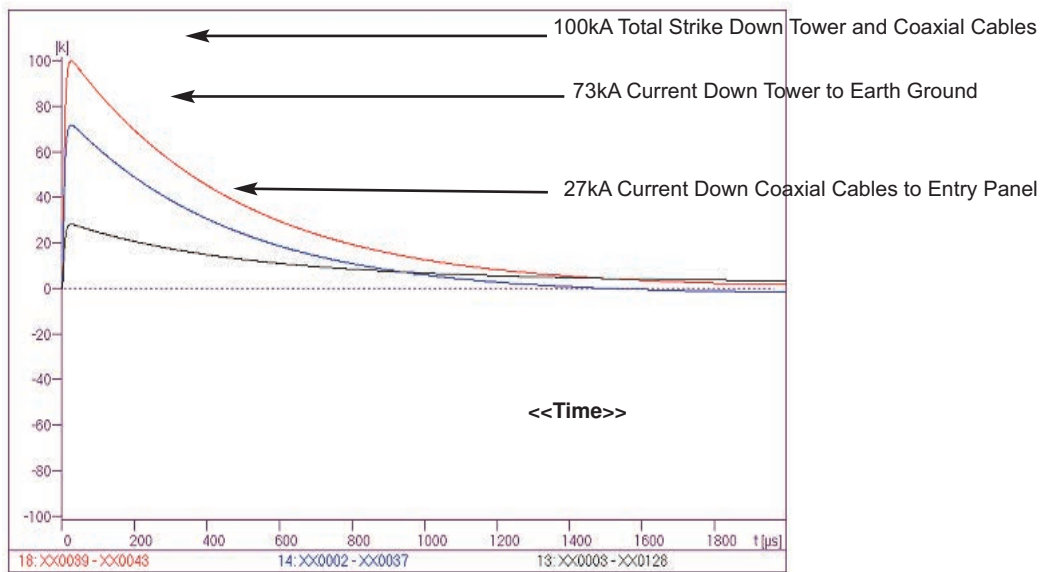

Most of the lightning energy goes down the tower to earth with current divided between the entry panel ground system and the earth ground connection. If coaxial cables on the tower were turned towards the entry panel at a lower point on the tower and shields were bonded to the tower there, less potential and current flow would be applied to the entry panel and master ground bar. Always direct cables to the entry panel at the lowest practical location on the tower.

The 27kA on the feeder cables divided by the 18 coaxial cables shown in the concept drawing equal 1.5kA per cable. A 7/16 DIN connector body could handle the coaxial cable shield current to ground and eliminate the requirement for shield grounding kits and an outside master ground bar. Isolate the “ice bridge” / cable tray structure from the entry panel. Only coaxial cables, dc power (if required), data cables, and tower light wiring should complete the circuit between the tower and entry panel.

### *Why Are Coaxial Cable Lightning Protectors Required?*

During a strike, a difference in potential arises between the coaxial cable shield and the center conductor at the equipment end of the cable. A coaxial cable will transfer rf energy efficiently from point a to point b with minimum losses at the operating frequency. But as the cable length is extended it attenuates higher frequencies according to the manufacturers specifications per unit length. The cable, in effect, becomes a low pass filter.

There is another factor called “velocity of propagation”. This term defines how fast, as a percentage of the speed of light (s.o.l.), an rf signal will propagate through a conductor. Typical specifications might be 98% s.o.l. for the cable shield, and 88% s.o.l. for the center conductor. These percentages are logically called Velocity factor ( $V_f$ ). An analysis of all the parameters involved is beyond the scope of this paper, but can be understood with the following graph.

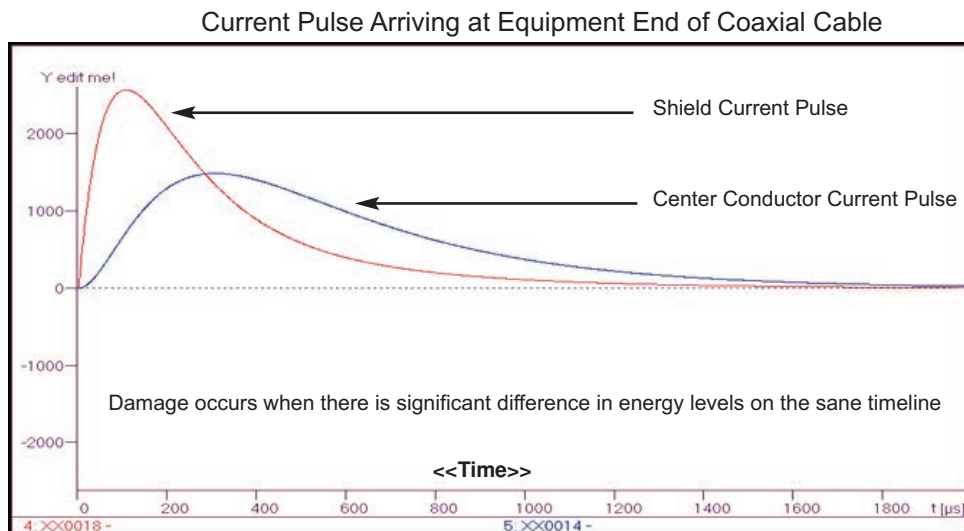

When lightning strikes the tower, the shield and center conductor at the antenna are simultaneously elevated in potential. Since there is more surface area on the shield, the propagation velocity will be faster, and high frequencies will not be as attenuated as on the slower propagating center conductor. This difference in propagation time and high frequency roll off of the fast lightning pulse rise time creates the voltage differential and subsequent damaging current flow through equipment.

A lightning protector does not stop, arrest, or confine lightning energy. A coaxial cable lightning protector equalizes the elevated potential on the shield with the yet to be elevated potential on the center conductor. First, it reduces the potential on the elevated shield (with a proper ground connection) causing reduced current flow through the equipment chassis. Then protector then applies the remaining shield potential to the yet to be elevated coaxial cable center conductor through an appropriate mechanical rf isolation device.

If the shield / chassis and coaxial cable center conductor are immediately brought to the same potential across the equipment’s input circuit, there will be little or no current flow through the input due to propagation caused delayed center conductor current. The input circuit will likely survive the strike. A “filter type” protector adds a mechanical dc blocking device (“capacitor”) to the center conductor to further reduce energy throughput to the equipment during a strike.

### *Coaxial Cable Protection When a DC Voltage is Present on the Center Conductor.*

When a dc voltage is injected on the coax center conductor, the protector must block low frequency lightning energy in the rf path, decouple the dc from the rf path, protect the dc to a rated value, and re-couple the dc to the center conductor. An ideal protector would be bi-directional.

When an rf coax protector designed to pass/protected dc is installed at an active antenna with remote power supply (e.g. a GPS receiver system), a protector at both ends of the coax is recommended (top and bottom). The top equipment protector has inserted a fast rise time equalizing pulse on the center conductor to protect the active antenna at the tower top, but the injected, rolled off and delayed pulse from the tower top protector will arrive at the power supply connector after the shield has been elevated in potential. Another coaxial protector installed close to the power supply will once again provide a lower impedance path for the center conductor pulse to a lower potential ground connection available on a lower floor. Your power supply input is no longer in the path and survives.

### *On Site Testing of Lightning Protection Devices*

After a severe thunderstorm with multiple tower strikes, how is a technician to know if the coaxial lightning protectors are still operating properly? There are some obvious visual indications of damage such as arcing / discoloration and melted / welded connectors, while the Return Loss / VSWR and Insertion Loss in the transmission line system could provide some indication of impending failure. But until now, there has been no simple field test to assure the protectors meet specifications.

The Times Protect LP-SPT Surge Protection Tester is designed to test all coaxial cable RF Lightning Protection products offered by Times Microwave. Other LP products based on transient protection devices such as GDT, MOVs, TVS and SIDACs and mechanical filter designs can be tested. Moreover the LP-SPT is suitable for testing discrete transient devices as well.



The LP-SPT consists of a battery operated high voltage dc power supply providing an output up to 1000 Volts at approximately 1-1.5mA. This output level provides enough voltage to cause breakdown of the transient device to occur without over-driving the device with excessive current; providing a reliable and valid method for measuring peak breakdown voltages of transient suppression devices. Although the test voltage is applied at a rise time rate of approximately 10kV/S, it is slow enough to facilitate valid testing of the device's rated "dc" breakdown voltage within the tolerance specified by the device manufacturer while staying within the 1000 Volt operating range.

The LP-SPT is a rugged, simple to use handheld test instrument. The LP-SPT has a 3.5 digit LCD that displays device under test peak breakdown voltage to a resolution of one Volt. Two type-N connectors (male and female) at the top of the LP-SPT provide direct connection of an RF LP device to the tester. An on-off switch and LED backlit "TEST" button facilitate operation and testing.

## Coaxial protector product types and IS-SPT test readings

**Gas Tube Type;** dc blocked, or non dc blocked "straight-through" permanent or replaceable gas tube.

A dc blocked protector uses a gas tube connected from the center pin of the "surge" connector to the protector body and a discrete component capacitor in series from the top of the gas tube to the "protected" connector center pin. The capacitor blocks dc current flow to a resistive component (rf coupling loop) long enough for the gas tube to "turn on" and equalize the center conductor to local ground potential. With center conductor and shield at the same potential, there is no current flow through the protected equipment input, and the equipment is undamaged. Dc blocking allows a very low energy pass-through to equipment. A dc blocked protector will have a specified frequency range to maintain proper impedance match through the device. LP-SPT test - from surge side connector, read 480 to 720 Volts with 600 Volt gas tube (e.g. LP-BTR/W series). Protected side connector, read high (800-900 Volts) open.

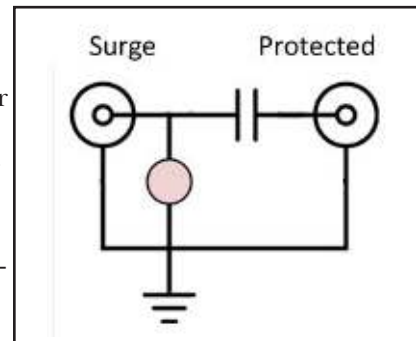

A non-dc blocked protector ("straight-through") will share the incoming current with a resistive component (rf coupling loop). The gas tube will turn on when the current through the resistive component in the equipment input rises enough to create a voltage drop reflected back to the protector's gas tube. A longer coax jumper cable from the protector to the equipment might produce a di/dt drop to forward bias and facilitate the gas tube turn on, reducing the required current flow through the protected equipment input. A non-dc blocked protector is bi-directional and can have a very wide frequency range, as much as dc to 7 GHz (Times Protect product), but will pass through more energy to the equipment than a dc blocked protector. Dc power to tower top equipment can be passed through a non dc blocked protector with gas tube turn on rated as close as possible to the required dc voltage. LP-SPT test – from either connector, read installed gas tube turn on voltage (as specified) +/- 20%

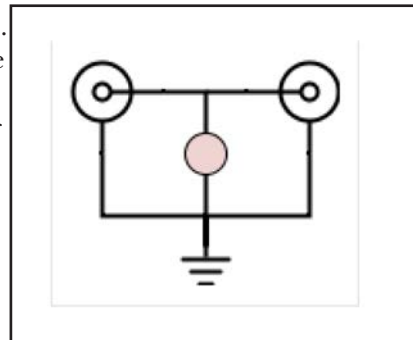

**Note:** Readout could "jitter" when the test button is continuously activated while testing a gas tube.

The LP-SPT is designed to provide an activation voltage with just enough current (approximately 1-1.5mA) to keep the gas tube ionized for "turn on" measurement without damage. Since there is not enough available current for a "hard turn on", the gas tube could be in an unstable condition during measurement. The range of "jitter" could be approximately the minimum and maximum acceptable voltage limit on the test reference guide supplied with the instrument.

**Dc blocked mechanical filters (no gas tube)** - Blocks dc and low frequency transient energy present during lightning strike. Instantaneous protection, no activation time.

A dc blocked mechanical filter has a high current rated inductor connected from the center pin of the “surge” connector to the protector body. A conductor is continued from the top of the inductor to a mechanical capacitor in series to the center pin of the “protected” connector. This forms a high pass filter with a sharp low frequency cut off and an extended high frequency band pass. As with any dc blocked protector there is a specified frequency range to maintain proper impedance match through the device. Dc blocking in a mechanical filter allows an extremely low energy pass-through to equipment. LP-SPT test - surge side connector and read very low approximately (0 – 2 Volts) shorted. Test protected side and read very high (800-900 Volts) open.

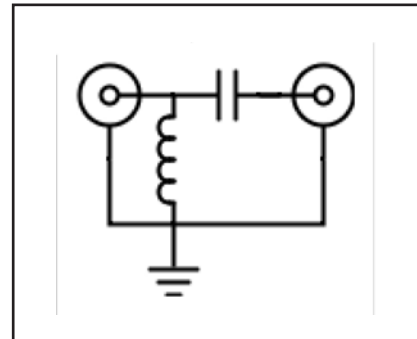

**Bi-Polar Diode Type** - Dc blocking in the rf path, and rf decoupled / re-coupled solid state dc pass/protect circuit for tower mounted preamp. Controls peak voltage to specifications during lightning strike.

The solid state dc pass/protect protector, with a dc blocking capacitor in the rf path from connector to connector, is bi-directional, and includes an rf isolated high current bi-polar diode. The diode is rf decoupled with an inductor from each connector center pin. The two inductors are connected together at the top of the diode, and the diode is bonded back to the protector body. The diode turns on when the voltage exceeds approximately +/-5 Volts (see Times Protect LP-GPX-05 specifications). All incoming differential voltages are limited to 5-7 Volts with a short 12 Volt residual pulse. LP-SPT test - will display the lowest turn on transient device in a hybrid multi-component, dc pass/protect protector (read 5-7 Volts from either connector with LP-GPX-05)

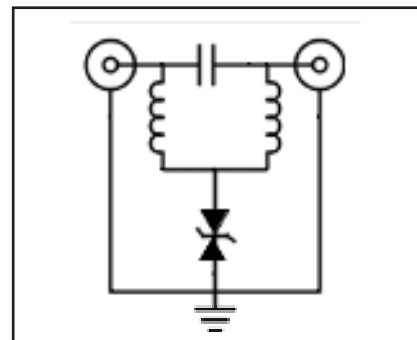

### *On site testing of ac power lightning / surge protectors*

Testing lightning protectors is most accurate and reliable when the protector is out of circuit and attached directly to the LP-SPT. If a coax jumper is used for convenience, *“know thy jumper”*. It must be tested and reliable! A dc blocked protector must be tested with the surge side connector attached to the LP-SPT. The protector can remain physically mounted with the equipment jumper attached. Turn off equipment!



A **non-dc blocked** protector must be disconnected at both ends. The protector can remain physically mounted. Test at either end.

A **dc blocked** mechanical filter must be tested with the surge side connector attached to the LP-SPT. It can remain physically mounted with the equipment jumper attached. Turn off equipment! The solid state dc pass/protect protector, with dc blocking in the rf path from connector to connector, must be disconnected at both ends. The protector can remain physically mounted. Test at either end.

**Note:** When removing and replacing site coax feeders or equipment jumpers during LP-SPT test procedure, make sure connectors are properly seated and equipment is operating normally before leaving site.

**Ac power protection** must be disconnected from power source and load. For 240 Volt Bi-phase devices, connect supplied alligator clip adapter to ac power input terminals

1. Connect alligator clips to neutral and ground, test and note results.
2. Connect alligator clips from each 120 Volt terminal to neutral, test and note results.
3. Connect alligator clips to both 120 Volt terminals (240 Volts), test and note results.

Test results should agree with manufacturer's turn-on specifications +/- 20%.

Testing telephone interfaces and individual surge protection components.

Telephone interface Disconnect line in and line out.

1. Connect alligator clips to line input tip terminal and ground, test and note results.
2. Connect alligator clips to line input ring terminal and ground, test and note results.
3. Connect alligator clips to tip and ring terminals, test and note results.

Test results should agree with manufacturer's specifications +/- 20% for type of supplied service (POTS, DSL, etc).

**Individual components** A simple alligator clip connection to individual surge components is all that's necessary for testing. Some components could be polarity sensitive. Reverse connection to component if test reading is suspect.





## *RF Lightning Protectors and PIM-What You Need to Know*

In today's wireless architecture, another important issue is Passive Intermodulation (PIM). Passive Intermodulation distortion is generated when two or more RF signals pass through a non-linear junction. The below graphs provide visual illustration of this phenomenon.

Fig. 1 below shows the linear response of a proper contact, while Fig. 2 represents the behavior of a non-linear junction in the RF path. (Reprinted with permission From Microwave Journal – May 1995 Issue)

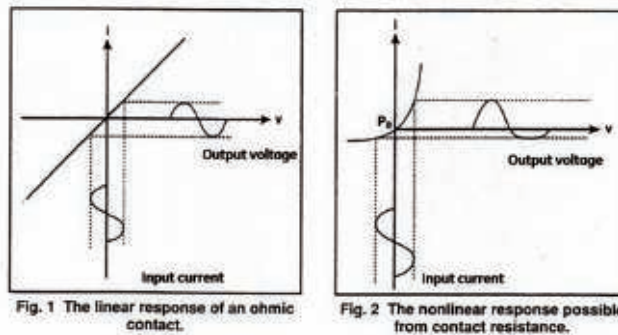

### *The Primary Causes For PIM Generation Are:*

- Dissimilar metals (galvanic action)
- Poor Surface Quality (roughness)
- Low Contact Pressure (improper torque or solder)
- Poor Contact Cleanliness (residual chemical films)
- Use of Magnetic Materials
- Changes in Temperature and current density

In-line RF lightning protection devices can contribute to PIM interference based on one or more of the above issues. For PIM sensitive applications, properly designed and tested lightning protectors should be selected and installed in accordance with required guidelines.

The below measurement is a Times Protect RF Lightning Protector design tested for PIM with two +43dBm (20W) carriers applied to the surge side connector. Sample was taken “off the shelf” to provide an objective evaluation.

Times Microwave Systems - Times Protect low PIM designs.

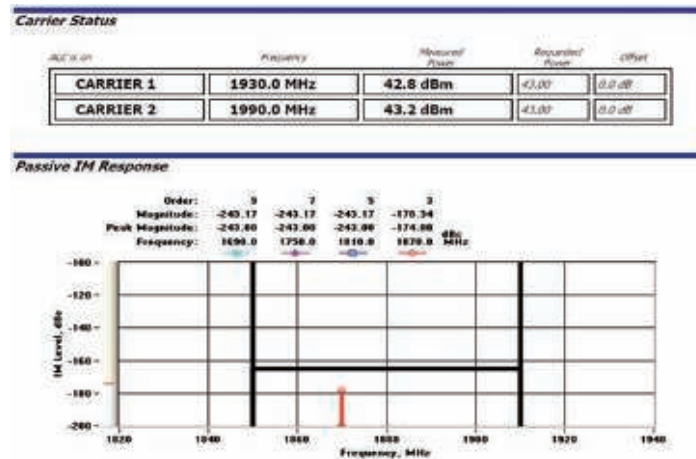

The Times Microwave Systems low PIM line of Lightning Protectors for PIM sensitive applications is a broadband design with center conductor DC blocking and inductive decoupling of center conductor to shield/ground. Several static and dynamic tests were performed to ensure reliable data capture. The measured PIM value for the LP-STR and LP-STRL series protectors is -174 dBc with a specified minimum value of -160 dBc.

Manufacturers of RF Lightning Protection Devices for PIM sensitive applications should factor the following practices into design, manufacturing process, and final inspection / testing:

- Proper selection of RF protection circuit topology utilizing PIM “friendly” components.
- Materials and plating techniques ensuring minimum dissimilar galvanic junctions.
- Materials utilized in protector design and assembly should be free of any roughness
- Use of materials with Magnetic Properties should be avoided in protector design.
- Plating of internal components for RF protection circuit should be carefully controlled.
- Final inspection and testing must consist of PIM sweeps in both dynamic and rest conditions
- Every RF Lightning Protector for PIM sensitive application should be PIM certified.

In addition to the above recommendations, ensuring “clean” installation of any in-line RF components, including a Lightning Protector, is critical to overall system performance. Proper connector torque, avoidance of dissimilar metals (galvanic junctions) as well as weatherization of components exposed to outside weather will yield stable long term performance for a wireless site. Site maintenance and periodic check of RF system interconnecting cables and connectors is critical to eliminating PIM issues over the long run. At Times Microwave Systems, all the above practices are taken into account while designing and manufacturing products for PIM sensitive applications.

## *Site Grounding Principles*

The Lightning Event has a set of electrical characteristics defined by its electrical current waveshape “reacting” with the series inductance of whatever conductor(s) it traverses. The current rise time to 90% of peak value, when observed in the frequency domain, will produce frequencies in the rf range. When the conductor’s inductive and capacitive reactance are considered with the terminating earth ground “resistance”, a range of impedance values from the generated rf frequencies are produced. This range of impedance values determines the waveshape and peak current on the grounding conductor.

The peak voltage across the length of the conductor will be maximum at the insertion point (top), diminishing to whatever Ground Potential Rise (GPR) caused by current insertion to the ground system is measured referenced to the outside world. It is the peak voltage, referenced to the outside world, produced from the series impedance of the grounding method that causes damage as peak potential seeks a lower potential through the wireless equipment circuitry.

We have examined lightning characteristics, sources of damaging energy, and how to save equipment from damage using large low inductance conductors draining off strike energy to ground. Coaxial cable center conductor lightning protectors present a lower impedance preferred path to ground for individual circuit protection. In all cases proper grounding and protection techniques offer alternatives to uncontrolled lightning damage. The earth (referenced as “ground”), is the electrical “return” for lightning strike energy. It is nature’s balance for a continuing sequence of natural phenomena.

### *What Are The Electrical Differences Between a Free Standing Tower, And a Roof Top Installation (As Described In This Discussion)?*

With a free standing tower, the coax shield is grounded to the tower then “pulled away” towards the shelter. If the coax is “pulled off” above earth ground, the tower becomes a voltage divider during a lightning event. The voltage drop, referenced to local ground potential developed at the coax entry panel to earth, is delivered to the top of the rack unless specific grounding measures are implemented.

A lightning ground system at a communications site should be capable of dispersing large amounts of electrons from a strike over a wide area with minimum ground potential rise (GPR). GPR can also mean any difference in voltage within the strike’s local sphere of influence (step potential). The lightning ground system should be capable of doing this very quickly (fast transient response). By spreading electrons out over a wide area, the step potential for any smaller given area would be reduced. The speed, or transient response of the ground system would be dependent on the geometry and combined inductance of the below grade conductive components, and the resistivity/conductivity of the soil “shunting” those components. The lower the inductance of the system components and soil resistivity, the lower the impedance at higher frequencies, the faster the ground system could disperse electrons.

A lightning ground system can be an excellent ac power ground. An electrical code approved ac power ground may not be good lightning ground.

Strike energy to the tower base, and energy through the coaxial cable shields to the entry panel ground can quickly saturate a ground system and elevate potential throughout the site referenced to the “outside” world. Ac power lines, telephone, data, control and alarm lines all represent paths to a lower potential for incoming strike energy from the tower. Unfortunately, valuable equipment might be in between the strike energy and a lower potential.

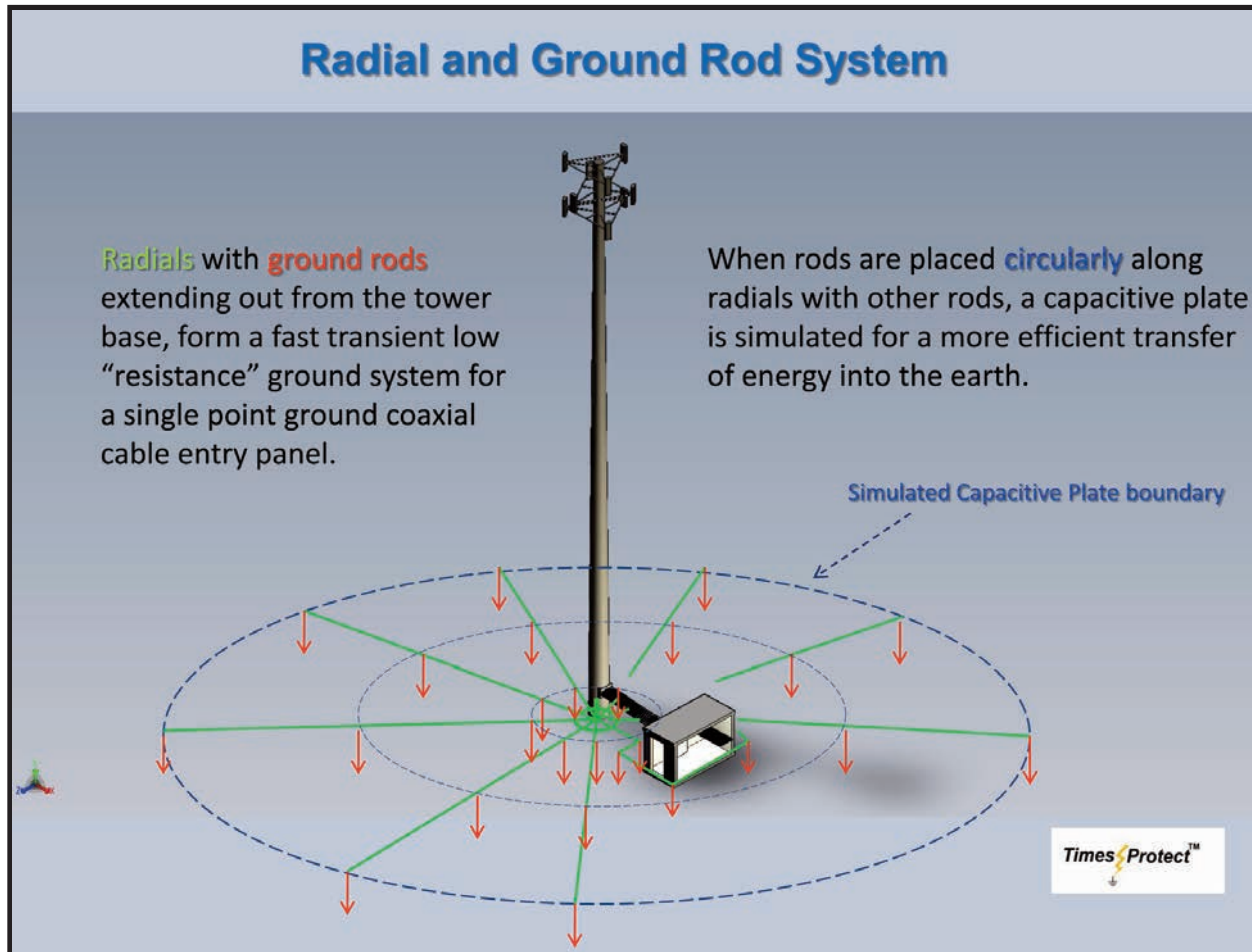

Consider the lightning grounding system as an rf circuit. Ground rods have a series inductance bridged by earth’s resistance. Connecting ground rods along buried conductors (radials) presents a series inductance (bridged by earth resistance) with additional ground rods along the radial’s length. The additional ground rods (inductance) can be considered in parallel, all bridged by earth’s resistance. Multiple radials with ground rods are all electrically in parallel to further reduce inductance. Multiple buried conductors (radials and rods) with attention to geometry and materials will net a good reading on a ground resistance tester and have an enhanced transient response as well.

One or two ground rods for a residence, a ground loop around a commercial building, or a loop and three ground rods around the base of a communications tower might meet code, but will not disperse the strike energy quickly enough to keep the GPR low. Effort and money spent up front on proper grounding will reduce downtime and equipment damage. If attention is not given to grounding, it’s a save now pay (more) later situation.

## Roof Top Installation

In a rooftop installation, all is at the same high peak potential during a lightning strike. The risk to wireless equipment on the roof increases if it is not connected to a common single point ground. A risk to equipment connected in the basement occurs if the coax cable has not been properly grounded on the roof to equalize the coax shield, with additional grounding kits on the way down and at the bottom, “bleeding off” more current from the coax shield. In both tower and roof top installations coaxial lightning protectors are required.

Electrical equipment “grounding” on a rooftop is a requirement to meet the electrical code. Standards and accepted practices are available to meet the code and are usually followed on a commercial rooftop. Large short conductors bond conductive rooftop structures, and an existing structural lightning protection system (lightning rods) to equalize rooftop potentials during a lightning event.

There is no “ground” on a rooftop during a lightning strike. The peak potential on the roof rises and falls (over time) due to the overall inductance / impedance of all downward conductors in matrix. Equipment is subject to high peak potentials until current flow down the conductors reduces the peak voltage. Lower inductance / impedance ground conductors reduce equipment damage exposure over time.

Local “Ground” is accepted to mean the building foundation Ufer effect, external buried ground loops and structural lightning system ground rods, all interconnected to the electrical ground at the power company main entrance panel. Some ground systems keep the structural lightning protection system ground rods separate from the building ground.

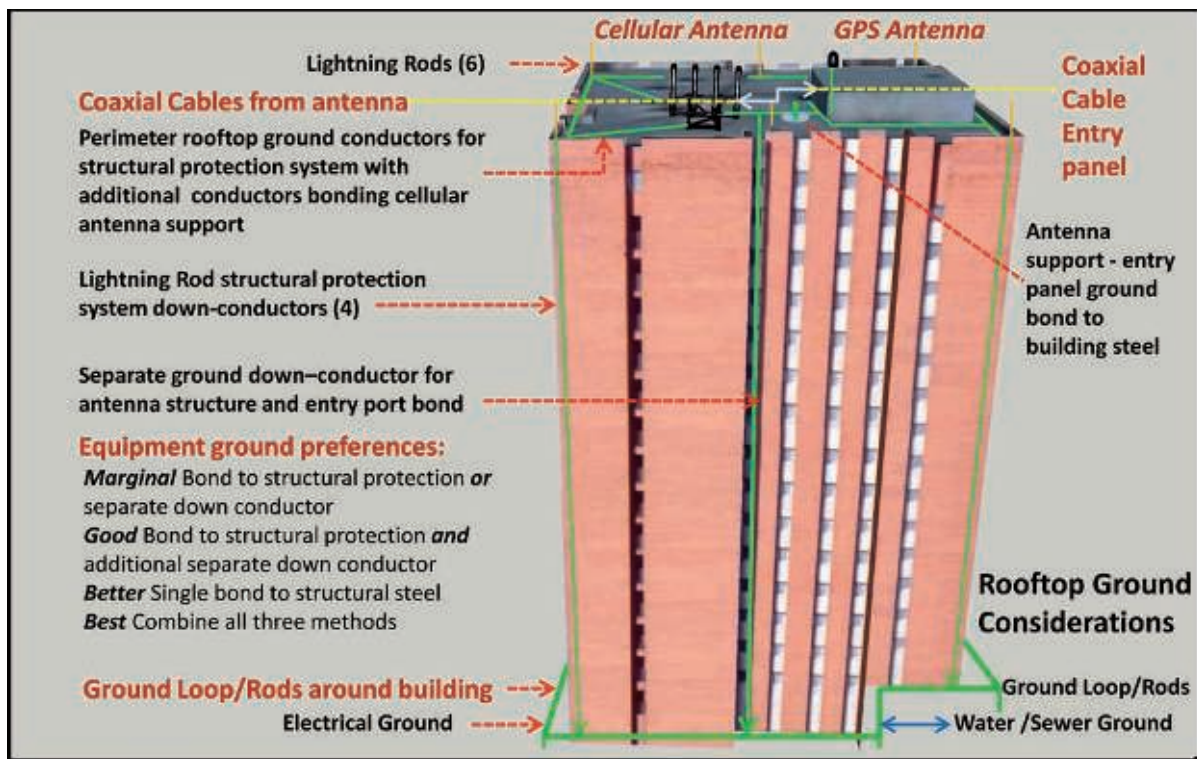

### *Roof Top Installation (continued)*

Various methods can be used to equalize ground potential on a rooftop installation. A building with steel beam construction is by far the best path to equalize earth and rooftop potentials. Other alternatives could be multiple rooftop connections to concrete encased reinforcing bars, large conductive water pipes, or the multiple electrical down-conductors in the structural lightning protection system.

All the above grounding methods can present a very low resistance to ac current flow from a rooftop power fault, or the dc component of a lightning strike to the established earth ground below. The overall Inductance, Capacitance, and Impedance to earth ground of the above methods are of little consequence at dc or 60 Hertz ac power frequencies, but become a significant factor during a lightning event.

*EMT conduit enclosed ground conductors* or coaxial cable to antenna is not a good idea. Lightning ground conductors must not be run through EMT conduit. The ground conductor's impedance at lightning's range of transients will be increased if the ground conductor is not bonded to the conduit at both ends.

If current carrying coaxial cable is in a metal conduit, a coaxial cable ground kit must be installed where the coaxial cable goes in and comes out of the conduit. The coaxial cable shield must be bonded to the metallic conduit at entry and exit. If not done this way, the conduit can act as a choke impeding shield current flow. The potential on the coaxial cable shield could arc through the cable insulation to the metallic conduit. If it is non-metallic conduit, there isn't a problem.

*Coaxial cable protectors* equalize the center conductor potential with the shield potential during a lightning strike by inserting a lower impedance path for peak lightning currents than the protected equipment circuitry. Since the center conductor is brought to peak potential through the protector, the equipment input is not in the path and survives.

### How do I know If I Have a “Good” Lightning Ground?

The first thing is to find and inspect it. If it's a minimum installation to meet code, it's probably not good enough. There are ground “resistance” test sets available to give you a measurement value. For example, a residential ground is considered acceptable at 20 Ohms, and 5 Ohms is thought to be an adequate tower ground measurement. Be aware that the method and set-up used to determine a ground system's "Fall of Potential Resistance" (FOP) is open to many variables and interpretations.

Soil composition and moisture can affect a ground system's ability to absorb electrons and varies by terrain and depth. Before a ground system is installed, a series of 4-stake ground resistivity measurements in the proposed area should be taken. This series of measurements would include multiple resistance readings in areas of interest, and data on resistance vs. depth. The returned data is interpolated into value called Ohm-m or Ohm-cm (not Ohms per meter).

There are formula available that use resistivity data to design a ground system to a specified FOP target resistance by utilizing various sized conductors and electrodes. To dig trenches and bury copper without this information could be a waste of time and resources.

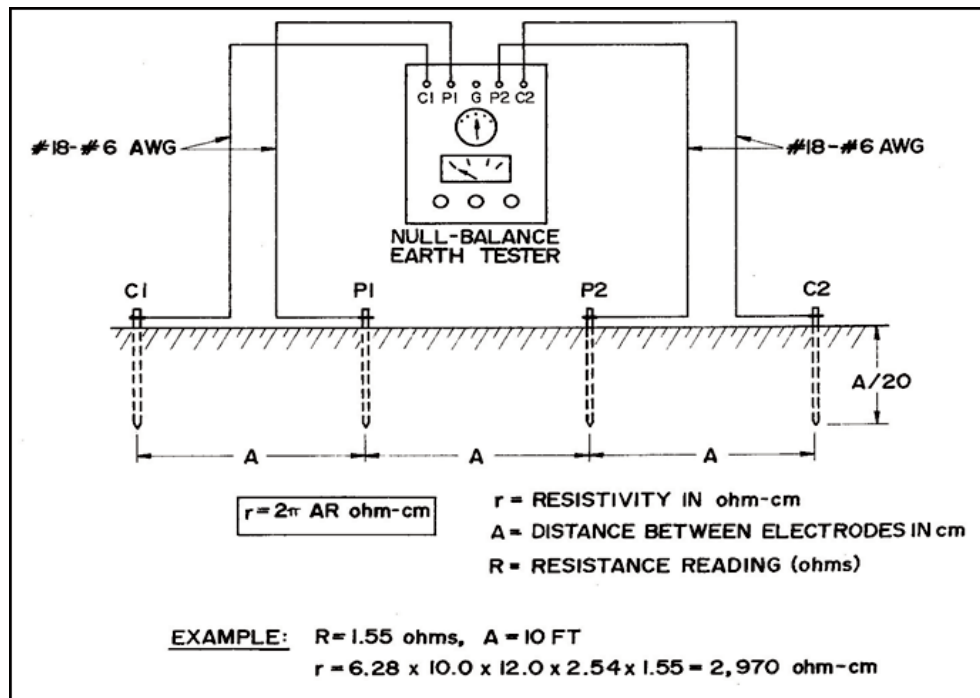

Ref: FM-11-490-9

After the ground system is designed using the 4-stake resistivity measurement results, performance after construction can be verified by using the 3-stake fall of potential measurement (FOP) below. Ground “resistance” is the meter reading when rod 3 is at 0.618 the distance of rod 1 to rod 2 and the graph “flattens” as shown below

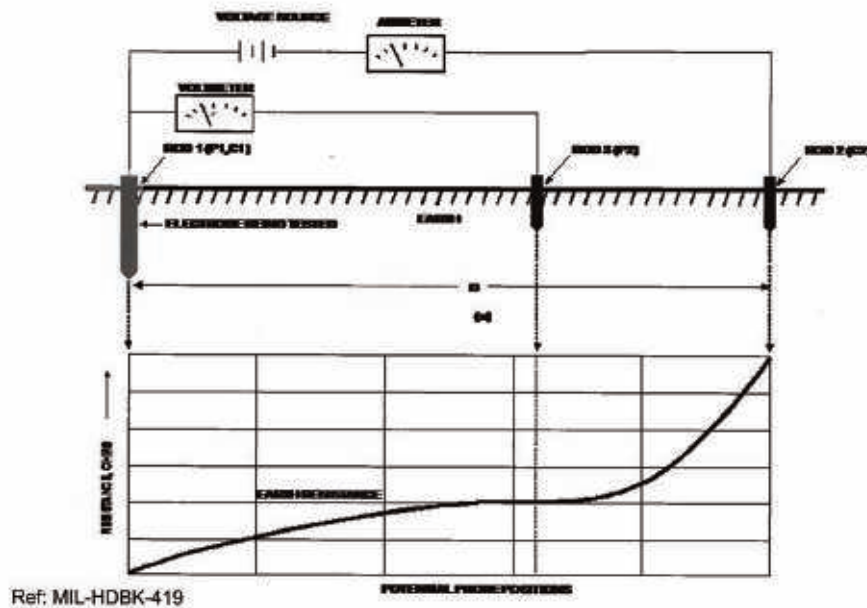

There are two types of ground test sets in use today. The first is the traditional FOP test set where three rods are driven into the earth, connected back to the test set, and a calibrated ac current (100-300 Hz) is passed between them in ways to facilitate the kind of measurement required. Then there is the “clamp-on” ground test device that couples ac energy into each ground rod or “network” of rods and radials and calculates a reading directly in Ohms based on the timing and waveshape of the “reflected” energy. Although the FOP measurement with driven rods is considered more accurate, the clamp on device is easier to use and shows results close (opinion) to the FOP tester.

Most measuring devices use an ac source current in the low frequency range to calculate the earth impedance of the grounding component or system. So the returned measurement is really the impedance at specific frequencies between 100-300 Hz. This is a useful measurement for an ac power company or an electrician, but a communications technician at a tower site should regard these measurements with suspicion. He might ask "but what is the impedance at the higher lightning frequencies up to 100 kHz?" This writer knows of no easily field-able test equipment for that range. Proper ground system design is imperative.



## *How Is A Lightning Ground System Evaluated?*

There are many marketing driven versions of what will “save” equipment. Some say “buy our product and lightning will not strike your tower”, or put our product in the ground and you won’t need rods or radials, or yes, our protectors are guaranteed 100% to protect your equipment from lightning damage (what is really guaranteed?).

### *Summary*

A lightning protection “system” for a wireless communications site is a scientifically based, common sense integrated set of:

- Grounding design measurements ... Ground system design based on targeted FOP impedance using soil Ohm-m resistivity measurements, depth / length of radials, and length / diameter of rods and how many of each, all configured to IEEE ground system design parameters. To ensure a fast transient low earth ground, multiple rods and radials should be chosen to reach targeted FOP impedance.
- Tower to entry panel coaxial cable ... Bend away from tower towards equipment at lowest practical height above ground . Do not connect tower cable tray to entry panel. Only active rf, dc, data, and tower lightning should complete the tower to entry panel circuit.
- There is no “ground” on a rooftop during a lightning strike. The peak potential on the roof rises and falls (over time) due to the overall inductance/impedance of all downward conductors in matrix. Equipment is subject to high peak potentials until current flow down the conductors reduces the peak voltage. Lower inductance/impedance ground conductor values reduce equipment damage exposure.
- Entry panel ... provides coaxial cable connector termination, lightning protectors, and a low inductance, large surface area conductor to a “single point ground” connection. The entry panel is your “last chance” to reduce damaging incoming currents from the tower or coaxial cables.
- Install lightning protectors on all circuits subject to damaging currents. All protectors should be bonded to the site “single point ground”.

Any shortcut during design and installation of any part of the lightning ground system reduces the level of protection of the whole (“weakest link”).

*Notes:*

*Notes:*

## **About *TIMES MICROWAVE SYSTEMS***

Times Microwave Systems, was founded in 1948 as the Times Wire and Cable Company. Today, the company specializes in the design and manufacture of high performance flexible, semi-flexible and semi-rigid coaxial cable, connectors and cable assemblies. With over 60 years of leadership in the design, development, and manufacture of coaxial products for defense microwave systems, Times Microwave Systems is the acknowledged leader, offering high tech solutions for today's most demanding applications.

Cable assemblies from Times Microwave Systems are used as interconnects for microwave transmitters, receivers, and antennas on airframes, missiles, ships, satellites, and ground based communications systems, and as leads for test and instrumentation applications.

As a highly specialized and technically focused company, Times Microwave Systems has been able to continually meet the challenges of specialty engineered transmission lines for both the military and commercial applications, drawing upon our:

- Thousands of unique cable and connector designs
- Exceptional RF and microwave design capability
- Precise material and process controls
- Unique in-house testing capabilities including RF shielding/leakage, vibration, moisture/vapor sealing, phase noise and flammability
- Years of MIL-T-81490, MIL-C-87104, and MIL-PRF-39012 experience
- ISO 9001 Certification

In 2010, Times Microwave Systems introduced its Times-Protect™ line of lightning and surge protection solutions to address the challenging needs of wireless systems in the 21st century.

With over 60 years of Times Microwave Systems aerospace cable and connector technology experience and unparalleled design expertise, Times Microwave Systems' staff of Field Applications Engineers can help to provide the right solution for your interconnect applications.



World Headquarters: 358 Hall Avenue, Wallingford, CT 06492  
Tel: 203-949-8400, 1-800-867-2629 Fax: 203-949-8423  
International Sales: +1 (203) 949-8503 • +1 (800) 867-2629  
China Sales: No 318 Yuan Shan Road Shanghai, China 201108  
Tel: 86-21-51761234 Fax: 86-21-64424098  
[www.timesmicrowave.com](http://www.timesmicrowave.com)